

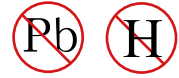

General Purpose Transistors

PNP Silicon



SC-89 / SOT-523

● **Absolute maximum ratings** (Ta=25°C)

Parameter	Symbol	Limits	Unit
Collector-base voltage	V _{CB0}	-60	V
Collector-emitter voltage	V _{CE0}	-50	V
Emitter-base voltage	V _{EB0}	-6	V
Collector current	I _c	-0.15	A (DC)
Collector power dissipation	P _c	0.15	W
Junction temperature	T _j	150	°C
Storage temperature	T _{stg}	-55~+150	°C

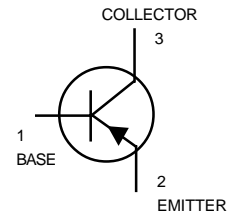
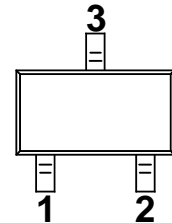

● **Electrical characteristics** (Ta=25°C)

Parameter	Symbol	Min.	Typ.	Max.	Unit	Conditions
Collector-base breakdown voltage	BV _{CB0}	-60	-	-	V	I _c =-50μA
Collector-emitter breakdown voltage	BV _{CE0}	-50	-	-	V	I _c =-1μA
Emitter-base breakdown voltage	BV _{EB0}	-6	-	-	V	I _E =-50μA
Collector cutoff current	I _{CB0}	-	-	-0.1	μA	V _{CB} =-60V
Emitter cutoff current	I _{EB0}	-	-	-0.1	μA	V _{EB} =-6V
Collector-emitter saturation voltage	V _{CE(sat)}	-	-	-0.5	V	I _c /I _B =-50mA/-5mA
DC current transfer ratio	h _{FE}	120	-	560	-	V _{CE} =-6V, I _c =-1mA
Transition frequency	f _t	-	140	-	MHz	V _{CE} =-12V, I _E =2mA, f=30MHz
Output capacitance	C _{ob}	-	4.0	5.0	pF	V _{CB} =-12V, I _E =0A, f=1MHz

● **Device marking**

2SA1774Q=FQ 2SA1774R=FR 2SA1774S=FS

● **h_{FE} values are classified as follows:**

Item	Q	R	S
h _{FE}	120~270	180~390	270~560

DEVICE CHARACTERISTICS

2SA1774Q/R/S

●Electrical characteristic curves

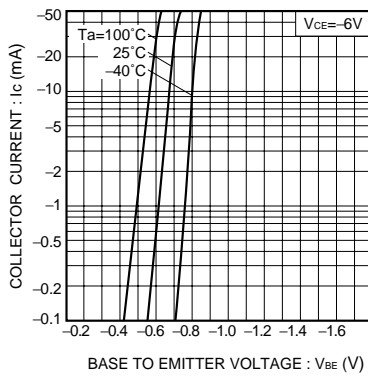

Fig.1 Grounded emitter propagation characteristics

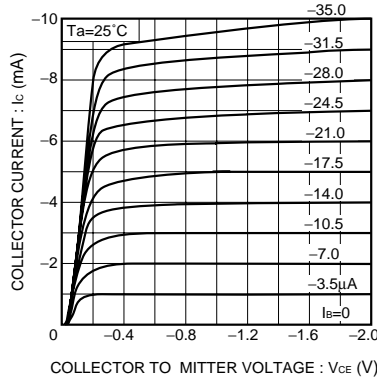

Fig.2 Grounded emitter output characteristics (I)

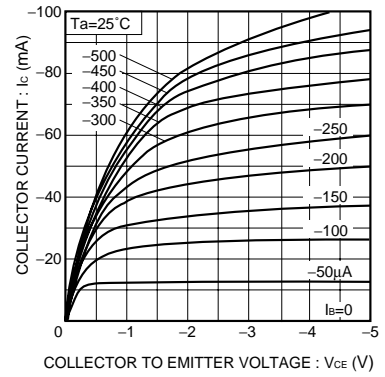

Fig.3 Grounded emitter output characteristics (II)

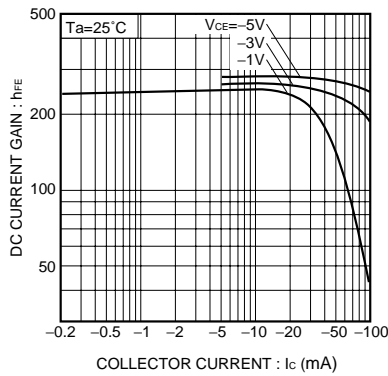

Fig.4 DC current gain vs. collector current (I)

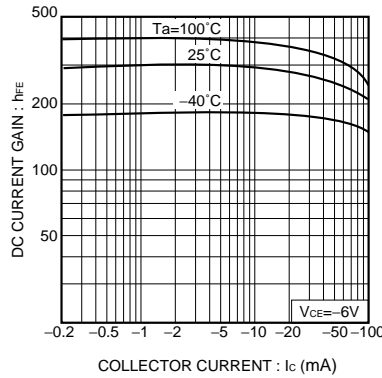

Fig.5 DC current gain vs. collector current (II)

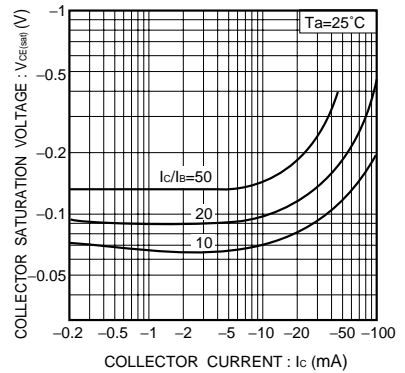

Fig.6 Collector-emitter saturation voltage vs. collector current (I)

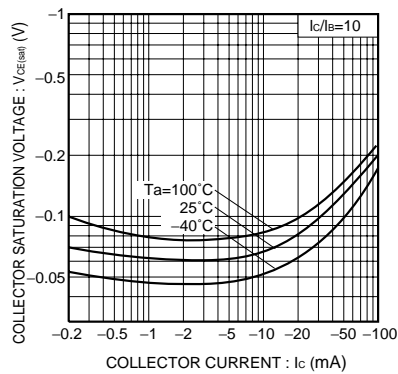

Fig.7 Collector-emitter saturation voltage vs. collector current (II)

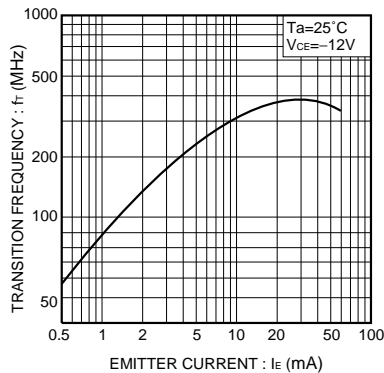

Fig.8 Gain bandwidth product vs. emitter current

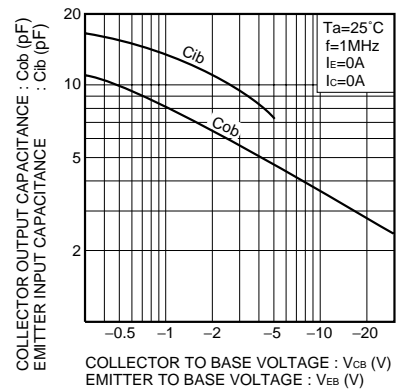
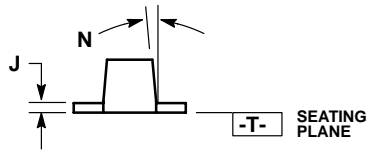
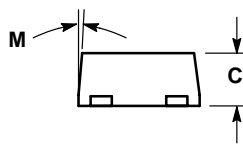
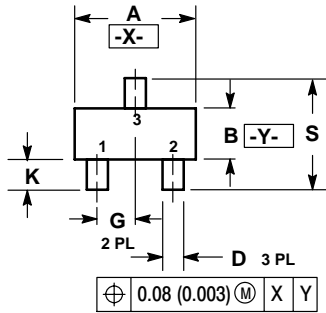

Fig.9 Collector output capacitance vs. collector-base voltage
Emitter input capacitance vs. emitter-base voltage

PACKAGE OUTLINE & DIMENSIONS

2SA1774Q/R/S

SC-89 / SOT-523



NOTES:

1. DIMENSIONING AND TOLERANCING PER ANSI Y14.5M, 1982.
2. CONTROLLING DIMENSION: MILLIMETERS
3. MAXIMUM LEAD THICKNESS INCLUDES LEAD FINISH THICKNESS. MINIMUM LEAD THICKNESS IS THE MINIMUM THICKNESS OF BASE MATERIAL.
4. 463C-01 OBSOLETE, NEW STANDARD 463C-02.

DIM	MILLIMETERS			INCHES		
	MIN	NOM	MAX	MIN	NOM	MAX
A	1.50	1.60	1.70	0.059	0.063	0.067
B	0.75	0.85	0.95	0.030	0.034	0.040
C	0.60	0.70	0.80	0.024	0.028	0.031
D	0.23	0.28	0.33	0.009	0.011	0.013
G	0.50 BSC			0.020 BSC		
H	0.53 REF			0.021 REF		
J	0.10	0.15	0.20	0.004	0.006	0.008
K	0.30	0.40	0.50	0.012	0.016	0.020
L	1.10 REF			0.043 REF		
M	---	---	10 °	---	---	10 °
N	---	---	10 °	---	---	10 °
S	1.50	1.60	1.70	0.059	0.063	0.067

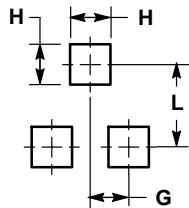

RECOMMENDED PATTERN OF SOLDER PADS